

# SEVILLA

REG 1W

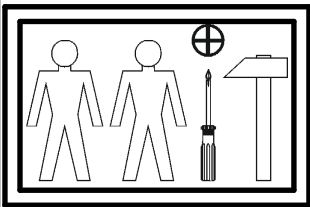

A	B	C	D	
1	S48-017	496	191	5/5
2	S48-160	2032	370	1/5
3	S48-161	2032	370	1/5
4	S48-211	500	395	2/5
5	S48-315	467	345	1/5
6	S48-316	467	370	1/5
7	S48-406	467	80	2/5
8	S48-507	350	120	1/5
9	S48-508	350	120	1/5
10	S48-510	418	120	1/5
11	S48-911	429	348	1/5
12	S48-918	1982	495	1/5
12	S48-050	1564	496	4/5

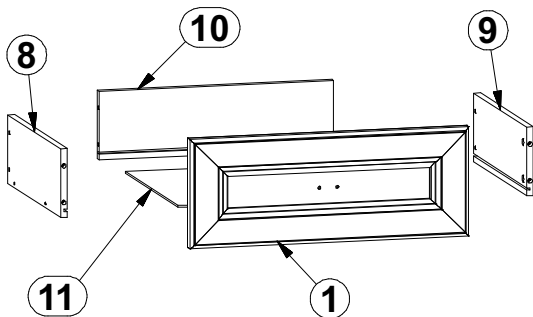
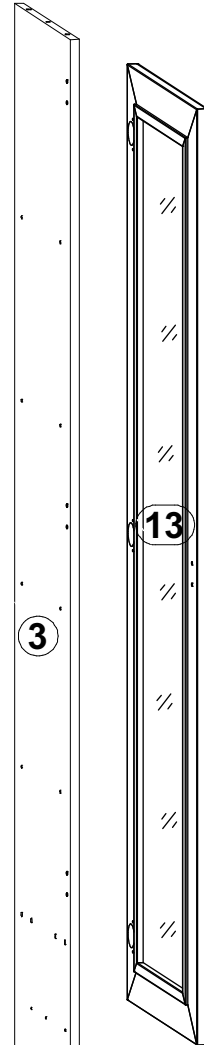
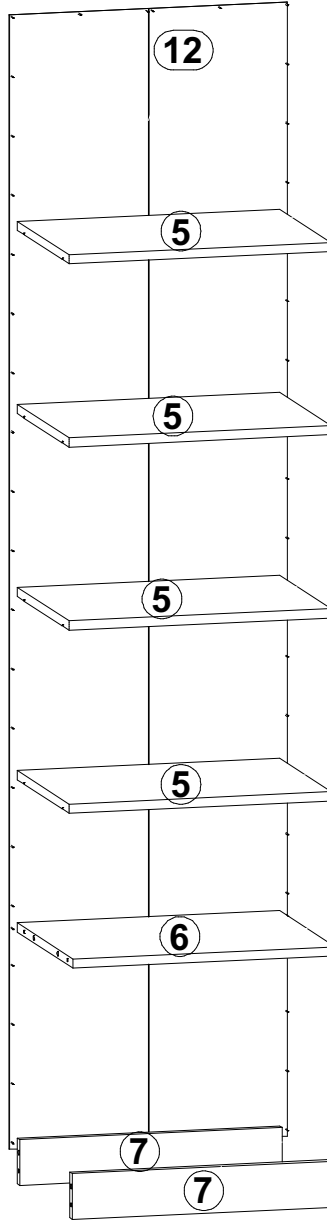
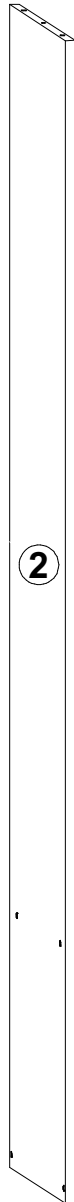
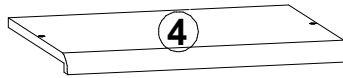
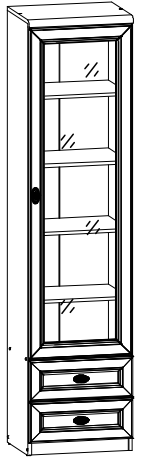
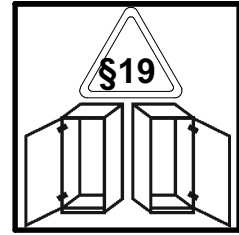

2x 32 mm <b>c180</b> <sup>1</sup>	16x φ5x17 mm <b>d1</b>	10x φ7x50 mm <b>e1</b>	8x φ5x9 mm <b>e19</b>	12x φ6x13 mm <b>e3</b>	12x φ8x30 mm <b>f1</b>	8x φ6.5x40 mm <b>f25</b>	4x M4x16 mm <b>j83</b>	4x <b>k1</b>
60x <b>l1</b>	4x φ3.5x16 mm <b>p38</b>	8x φ12x10.5mm #12 <b>r15</b>	8x <b>r16</b>	8x <b>s1</b>	2x 350 mm <b>w45</b> <sup>CL</sup>	2x 350 mm <b>w45</b> <sup>CR</sup>	2x 350 mm <b>w45</b> <sup>DL</sup>	2x 350 mm <b>w45</b> <sup>DR</sup>
1x <b>z1</b>	1x <b>n26</b> <sup>1</sup>	1x φ3.5x16 mm <b>p38</b>	2x M4x25 mm <b>j8</b>	3x <b>a44</b>	3x <b>b19</b> <sup>D5</sup>	6x φ3.5x15 mm <b>p51</b>	6x φ6.3x13 mm <b>e2</b>	1x 32 mm <b>c180</b> <sup>2</sup>

